

This manual covers the following B&B Electronics' model serial cards:

RS-232/422/485 Serial Cards €

3PXCC1a 3PXCC1b

3PXCC2a 3PXCC2b

Documentation Number 3PXCC1x-2x-3903

Each of these models is an RS-232 serial card and uses the same printed circuit board. The "1" and "2" suffix designates the number of ports on the card. The model number of the card is printed on a sticker on the board.

*This product designed and manufactured in Ottawa, Illinois USA
of domestic and imported parts by*

B & B Electronics

International Headquarters

B&B Electronics Mfg. Co. Inc.

707 Dayton Road -- P.O. Box 1040 -- Ottawa, IL 61350 USA

Phone (815) 433-5100 -- General Fax (815) 433-5105

Home Page: www.bb-elec.com

Sales e-mail: orders@bb-elec.com -- Fax (815) 433-5109

Technical Support e-mail: support@bb-elec.com -- Fax (815) 433-5104

European Headquarters

B&B Electronics Ltd.

Westlink Commercial Park, Oranmore, Co. Galway, Ireland

Phone +353 91-792444 -- Fax +353 91-792445

Home Page: www.bb-europe.com

Sales e-mail: orders@bb-europe.com

Technical Support e-mail: support@bb-europe.com

© B&B Electronics -- Revised October 2003

Table of Contents

Chapter 1: Introduction and General Information.....	1
Features	1
Specifications	1
Chapter 2: Quick Installation Guide	3
Chapter 3: Windows Installation	5
Checking Device Manager for Available Address/IRQ's (Windows 95/98)	5
Adding Serial Port(s) in Windows 95/98	8
Changing COM Port Resources in Windows 95/98	12
Checking Windows NT Diagnostics for Available Address/IRQ's (Windows NT 4.0)	15
Checking Windows 2000 for Available Address/IRQ's	18
Adding Serial Port(s) in Windows 2000	22
Chapter 4: Address and IRQ Setting	29
Address Switch Setup	29
Interrupt Jumper Setup.....	32
Chapter 5: Communication Jumper Settings	35
RS-232 Mode	35
RS-422 Mode	36
RS-485 Mode	36
RS-485 Pinouts.....	37
RS-485 Operation.....	37
RS-422 and RS-485 Termination.....	38
High Speed Mode.....	38
Chapter 6: Physical Hook-up and Troubleshooting	39
Pinouts.....	39
RS-232 Pinouts.....	39
RS-422 Pinouts.....	39
RS-485 Pinouts.....	40
Communication Cable Data	41
Troubleshooting.....	42
Appendix A: Hardware I/O Map	A-1
Appendix B: Declaration of Conformity Statement	B-1

Chapter 1: Introduction and General Information

The B&B Electronics' 3PXCC series serial interface cards are designed for the IBM PC, XT, AT and compatibles. Ports are configured as a standard DTE device, and connections are made on 9-pin D-style connectors.

The 3PXCC cards offer exceptional setup flexibility. The 3PXCC series has the ability to use any I/O address and any hardware interrupt. You can install as many serial ports as will physically fit in a machine. To use one of the "non-standard" addresses or interrupts, the serial software used must also offer that flexibility. If you are writing your own application, be sure the communications routines used support any address and IRQ. B&B Electronics' SimpCom Communications Drivers support these features.

Features

- Switch selectable addresses, from 0 to hex 3F8, including COM1 – COM4
- Jumper selectable interrupts: 2, 3, 4, 5, 6, 7, 10, 11, 12, 14, 15
- Enhanced 16 bit Address Decoding
- Baud rates up to 230.4K baud with 2X clock option enabled
- 16550A UARTs on all ports
- Supports all standard RS-232 lines: TD, RD, RTS, CTS, DSR, DCD, DTR, and RI

Specifications

Bus: IBM PC ISA Bus

Slot: Requires 1 full length slot for complete IRQ selectability. When installed in a short slot, IRQ's 10-15 will not be available.

Dimensions: 6.3 x 3.3 in (16.0 X 8.4cm)

I/O connection: 9-pin male, D-sub connectors

Baud rates: 230,400 baud max with 2x clock jumper enabled

Character length: 5, 6, 7, or 8 bits

Parity: Even, odd or none

Stop bits: 1, 1.5, or 2

Interrupt: IRQ 2, 3, 4, 5, 6, 7, 10, 11, 12, 14, or 15

Address: Switch programmable, 0 to hex 3F8

RS-232 Drivers:

Device: SN75185

Transmitter output voltage: ± 10.0 V minimum

Short circuit current: ± 12 mA typical

Input low level threshold voltage: 0.65 V minimum

Input high level threshold voltage: 2.5V maximum

Device will withstand ± 30 V

RS-422/485 Driver/Receiver:

Device: MAX491 or equivalent

Differential driver output voltage: 1.5 - 6 V

Differential input high-threshold voltage: 0.2 V maximum

Differential input low-threshold voltage: -0.2 V minimum

Automatic RS-485 Driver Control Timing:

Driver is enabled when data is a logic "0" (start bit). Driver remains enabled for one character transmission time (10 bits of

data at current baud rate). Each additional logic "0" resets the timeout.

Power Consumption (2-port model):

+5V, 180mA, 900mW

+12V, 50mA, 600mW

-12V, 65mA, 780mW

Total maximum power draw: 2.28 W

Chapter 2: Quick Installation Guide

The following steps will help you install the Model 3PXCC Serial Card. Please follow (step-by-step) the following numbered instructions and refer to any corresponding chapters for more details.

**CAUTION: Electrostatic Sensitive Device.
Use ESD precautions for safe handling.**

Before removing the card from the anti-static protective packaging.

- Discharge any static electricity buildup on your body by touching a large grounded metal surface or the metal chassis on equipment connected to earth ground by a 3-wire power cord.
 - Avoid touching the gold connectors or other parts on the card except as necessary. After setting the jumper, ground yourself to the computer chassis before and while inserting the card.
 - Remove AC power from the computer and unplug the power cord before inserting the card.
 - Retain the ESD bag for handling the card. Save the packaging for storage or shipping.
1. Make sure you have an available ISA slot for installing your B&B Electronics Serial Card. You may have to remove the cover of your PC.
 2. Determine what addresses and IRQ's are free to use on your PC by checking your operating system for unused addresses and IRQ's. Each port uses eight I/O address spaces starting at the base address that you select. Each port I/O address and interrupt request (IRQ) must be set as well. See "Checking Device Manager for Available Address/IRQ's" in Chapter 3 for your operating system. Refer to Chapter 4 (Table 3) for frequently unused I/O Addresses and IRQ's. Write down the address and IRQ you select to use. Do not physically install the ISA card at this point.
 3. Add New Hardware – This consists of adding a port or ports to your operating system. See "Adding Serial Ports" in Chapter 3 for specific instructions for your operating system.

4. Assign Address and IRQ – The address and IRQ are set in the operating system that you are using. This is the final step of adding new hardware. See Chapter 4 for more details.
5. Set up the address (with dipswitches) and IRQ (jumpers) on the serial card to reflect unused addresses and IRQ's that you want to use. The address dipswitch setting consists of configuring seven dipswitches that reflect a particular hex address. The IRQ is set via a little black jumper. See Chapter 4 for an explanation of address and IRQ settings as well as details on configuring the card itself.
6. Set serial card hardware jumpers for the communication parameters that you desire. See Chapter 5 for an explanation of serial parameters and details on how to configure them.
7. Shut down the PC before installing the serial card.
8. Install ISA serial card into an available ISA slot in the PC.
9. Physical Hook-up and Troubleshooting – pinout, cable data, and troubleshooting information. See Chapter 6 for more details.

Chapter 3: Windows Installation

Checking Device Manager for Available Address/IRQ's (Windows 95/98)

Click on Start / Settings / Control Panel and double-click on System Properties.

Left-click on Device Manager.

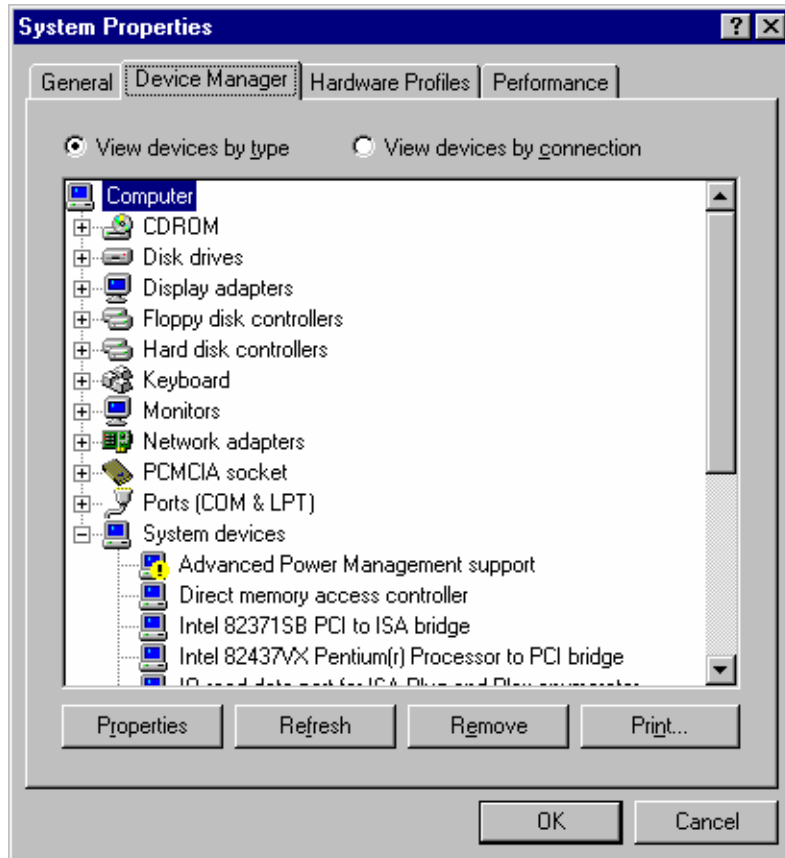

Double-click on Computer.

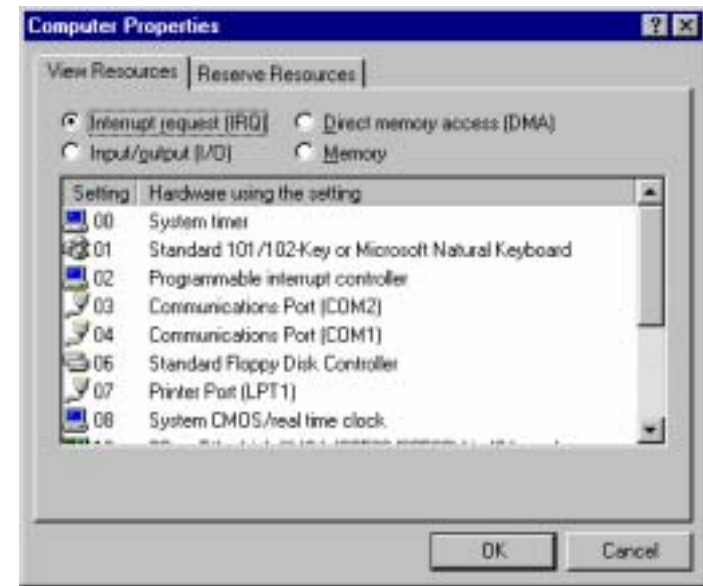

Left-click on Interrupt Request.

Find a free IRQ in the displayed list. Any number that is seen on the left hand side of this screen is an IRQ that is currently being used. The object is to find a number of IRQ(s) that are **not** listed and set your port(s) using those IRQ's.

Left-click on Input/Output (I/O).

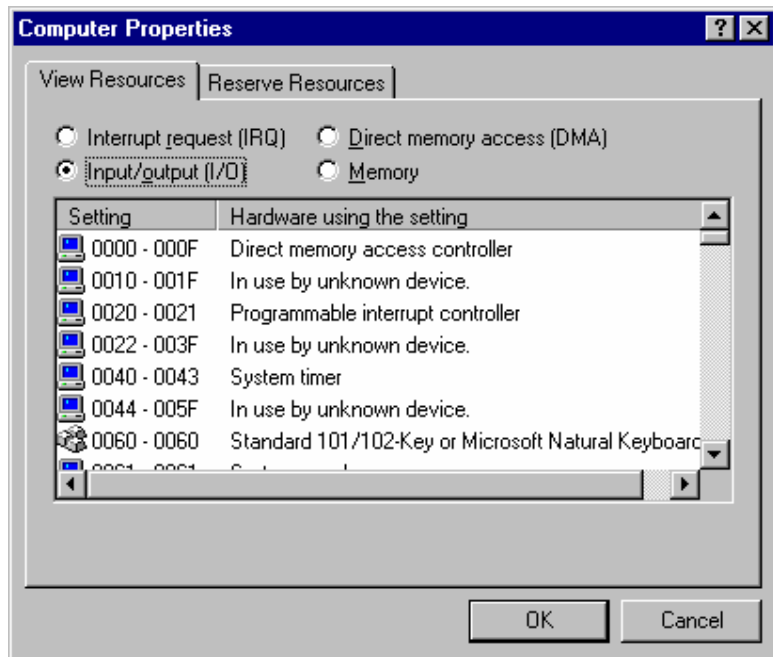

Scroll through the list, checking 03F8H, 02F8H, 03E8H, 02E8H. If one of these is available, use it. If not, check alternates.

Find a free address in the list. Most desktop PC's have a COM1 and possibly a COM2 already on their system which will be seen in the list. You might have to start at COM3 or COM4 to begin addressing the ISA card. If these addresses are used you may have to resort to the Frequently Unused Port Addresses (found in Chapter 4, Table 3) of this manual. Write these open addresses and IRQ's down for later reference.

Adding Serial Port(s) in Windows 95/98

Go to Start Menu / Settings / Control Panel.

Run the Windows Add New Hardware utility found in the control panel. Click Next.



Click Next.



Select No (you do not want Windows to search for your new hardware). Click Next.



Select Ports (COM & LPT). Click Next.



Select Yes/No for the device in the list. Click Next.

Select (Standard port types) and Communication Port. Click Next.



The next screen will show the address and interrupt request of the port. These may not match your configuration. For now, simply click Next. Windows may ask for the Windows 95/98 disk/CD to be inserted.

Finally, click Finish.

Changing COM Port Resources in Windows 95/98

Click Start / Settings / Control Panel and double-click on System Properties.

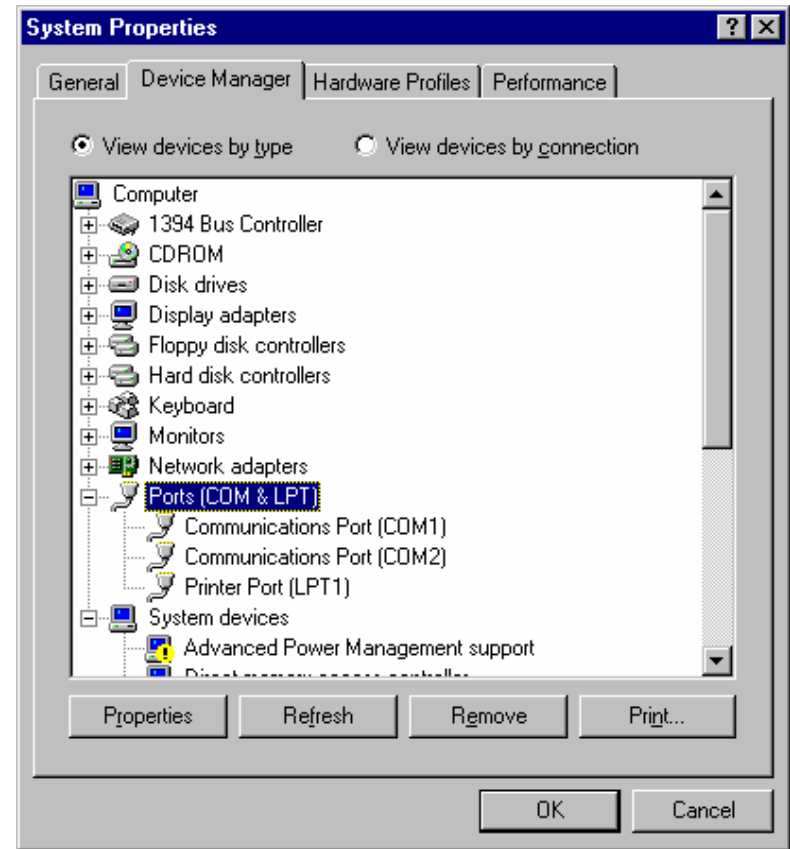

Click on Device Manager (make sure "View devices by type" is enabled).

Double-click on Ports (COM & LPT).

Double-click on the new port that has been added.

Click off (check mark out of box) Use automatic settings.

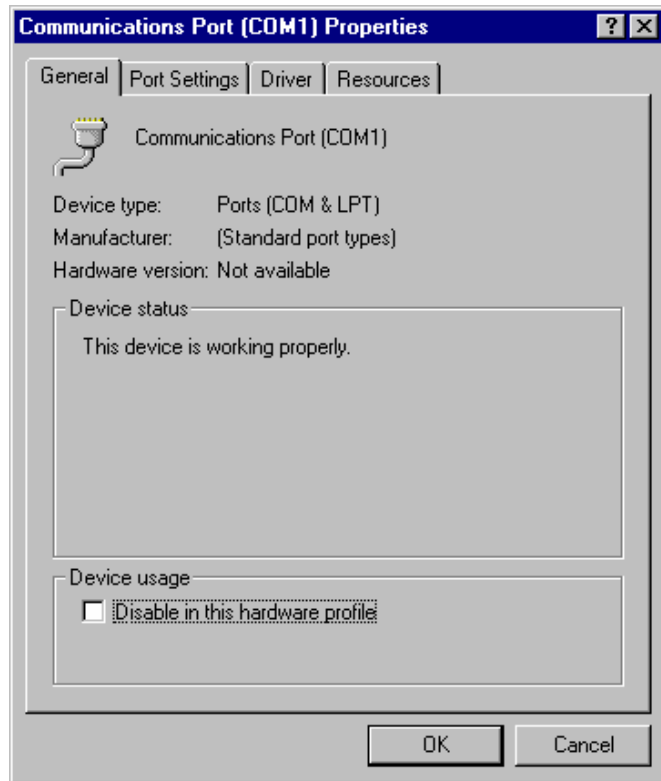

Click Resources.

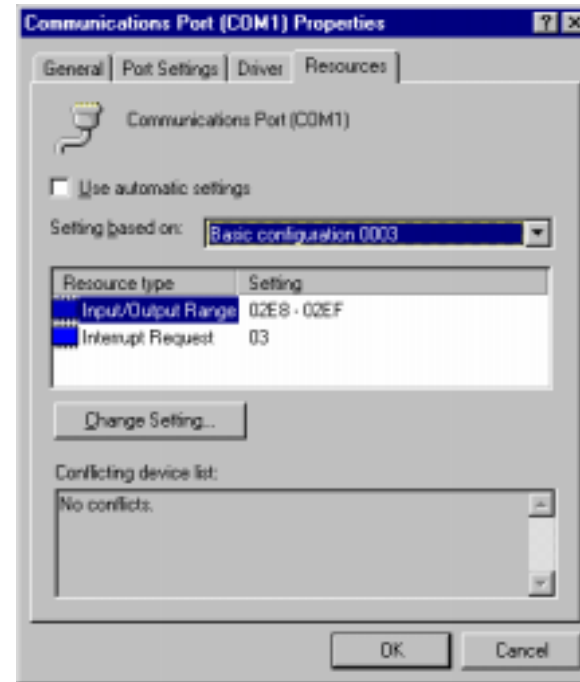

Select Basic Configuration 0007 (or last one).

Select Input / Output Range.

Click Change Setting.

Change Address to match the free address settings you found earlier.

Click OK.

Select Interrupt Request.

Click Change Settings.

Change IRQ to match the free IRQ settings you found earlier.

At this point you can shut down the system and physically install your B&B Electronics Serial Card into an available ISA Slot. Double check to make sure the addresses and IRQ's on the Serial Card are set to the correct settings.

Checking Windows NT Diagnostics for Available Address/IRQ's (Windows NT 4.0)

Click on Start / Programs / Administrative Tools / Windows NT Diagnostics.

Left-click on Resources.



Find a free IRQ in the following list. Any number that is seen on the left hand side of this screen is an IRQ that is currently being used. The object is to find a number of IRQ(s) **not** listed and set your port(s) using those IRQ's.

Left-click on I/O Port in Resources. Tab to view currently used addresses.

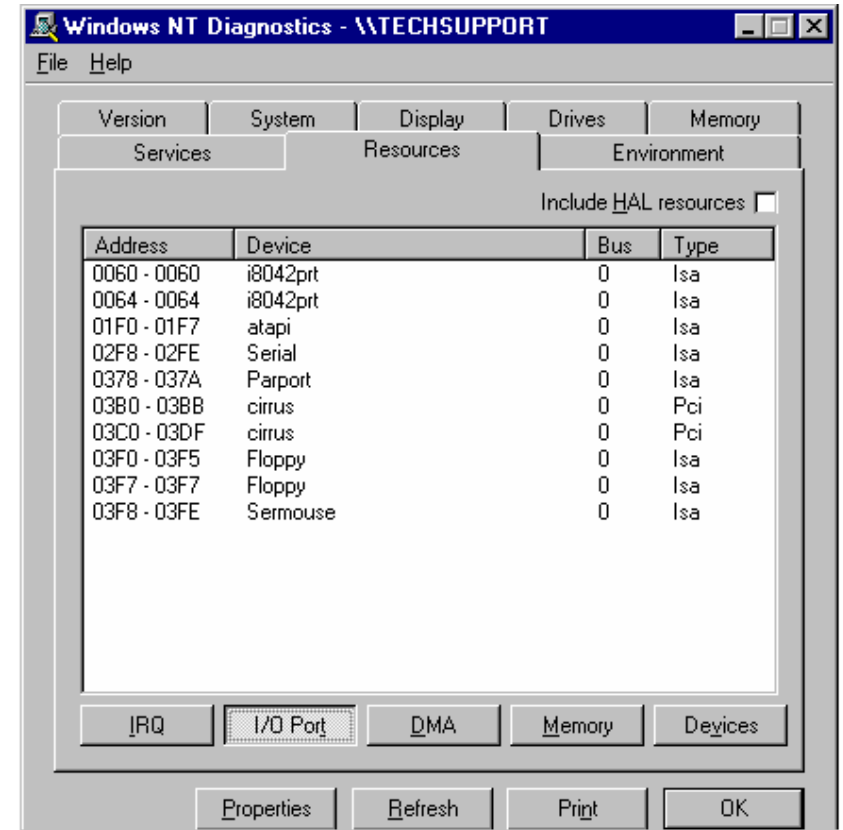

Scroll through the list, checking 03F8H, 02F8H, 03E8H, 02E8H. If one of these is available, use it. If not, check alternates.

Find a free address in the list. Most desktop PC's have a COM1 and possibly a COM2 already on their system, which will be seen in the list. You may have to start at COM3 or COM4 to start your addressing of the ISA card you have. If these addresses are used you may have to resort to the Frequently Unused Port Addresses (found in Chapter 4, Table 3) of this manual. Write these open addresses and IRQ's down for later reference.

Adding Serial Port(s) in Windows NT 4.0

Go to Start Menu / Settings / Control Panel.

Double-click on Ports.

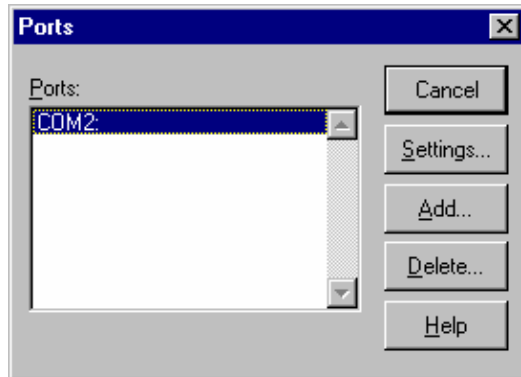

Click Add.

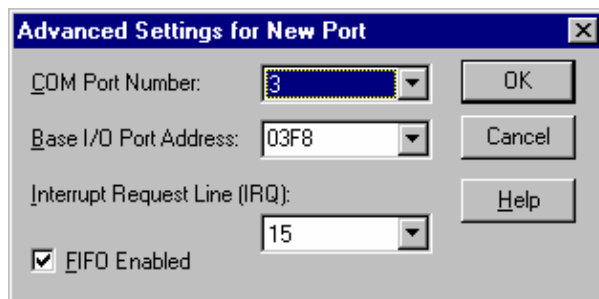

Choose COM Port Number, Base I/O Address, and IRQ that you want to use for the new Serial Port(s) being added.

After clicking OK, you will see a screen – System Setting Change. Click the button Restart Now to restart Windows NT 4.0.

At this point you can shut down the system and physically install your B&B Electronics Serial Card into an available ISA slot. Double check to make sure the addresses and IRQ's on the Serial Card are set to the correct settings.

Checking Windows 2000 for Available Address/IRQ's

Click on Start / Settings / Control Panel.

Double-click on System.

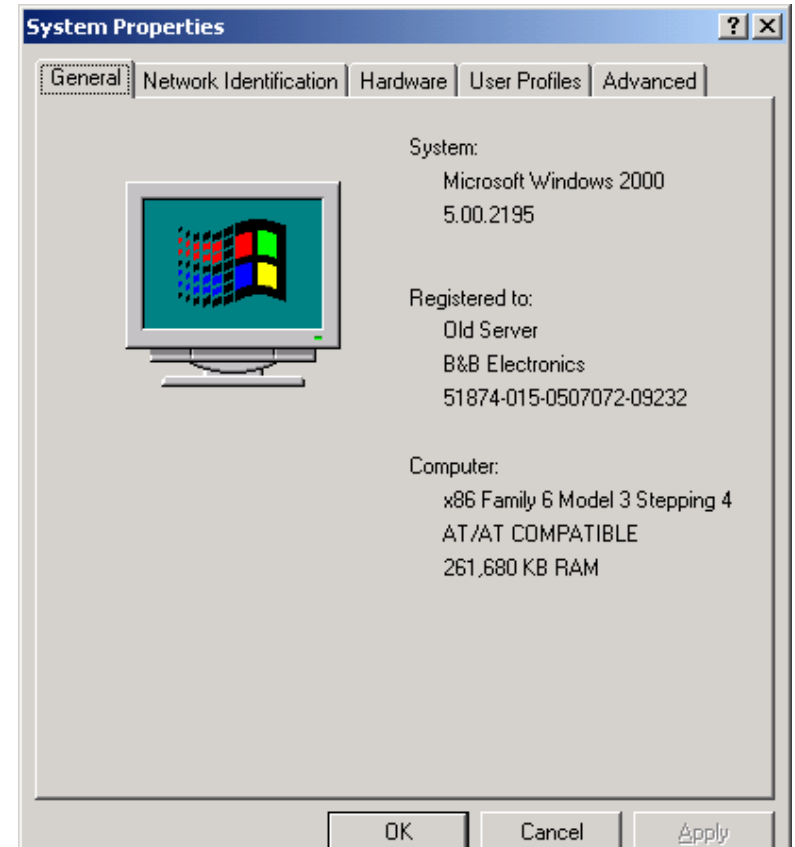

Click on Hardware.

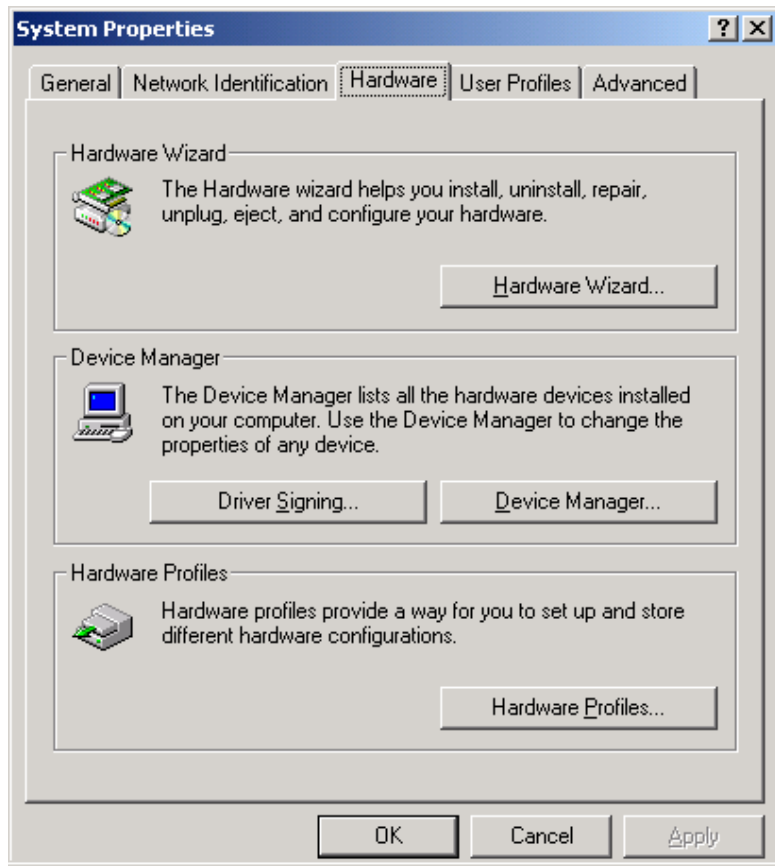

Click on Device Manager.

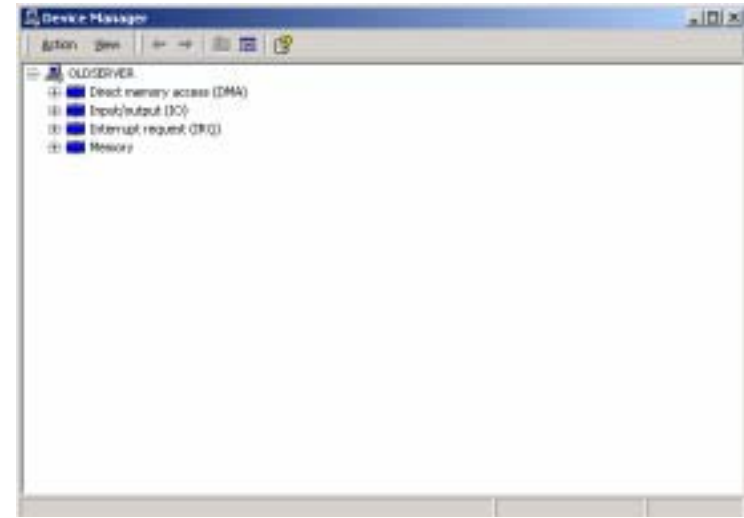

Click on View (top of screen).

Click on Resources by type.

Double-click on Input/Output. Find an unused address to set your B&B Electronics serial card to.

Scroll through the list, checking 03F8H, 02F8H, 03E8H, 02E8H. If one of these is available, use it. If not, check alternates.

Find a free address in the list. Most desktop PC's have a COM1 and possibly a COM2 already on their system, which will be seen in the list. You may have to start at COM3 or COM4 to start your addressing of the ISA card you have. If these addresses are used you may have to resort to the Frequently Unused Port Addresses (found in Chapter 4, Table 3) of this manual. Write these open addresses and IRQ's down for later reference.

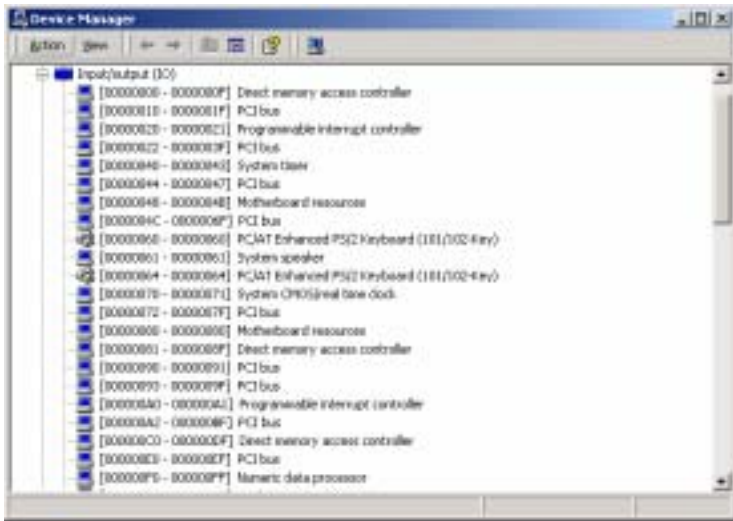

Double-click on Interrupt Request (IRQ). Here you need to find an unused IRQ to set your B&B Electronics serial card to.

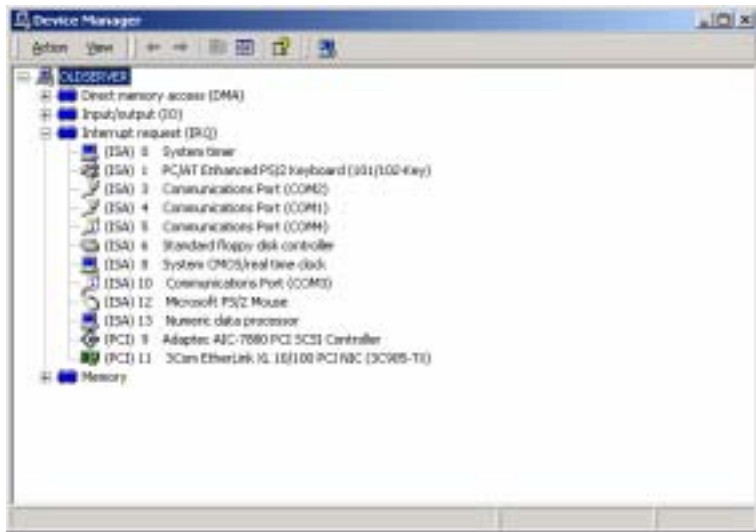

Adding Serial Port(s) in Windows 2000

Go to Start Menu / Settings / Control Panel.



Double-click on Add/Remove Hardware.



Click Next.

Click on Add/Troubleshoot a device.

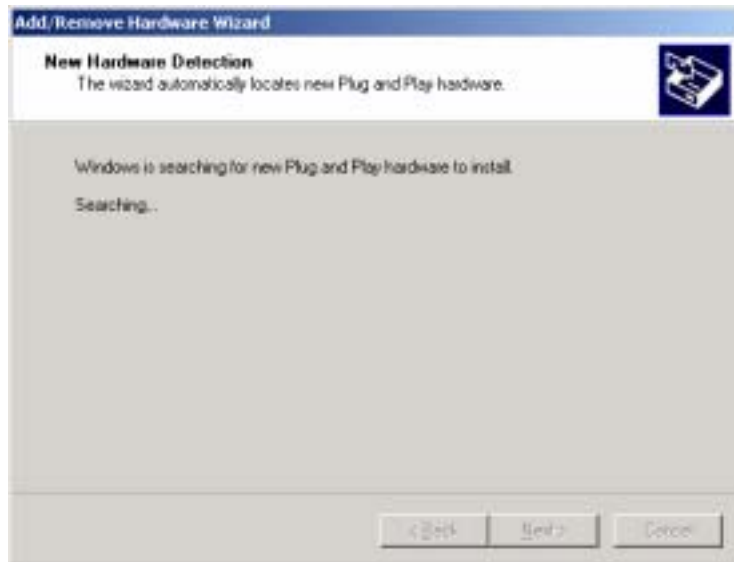

Click Next.

The following screen will appear after a few seconds.

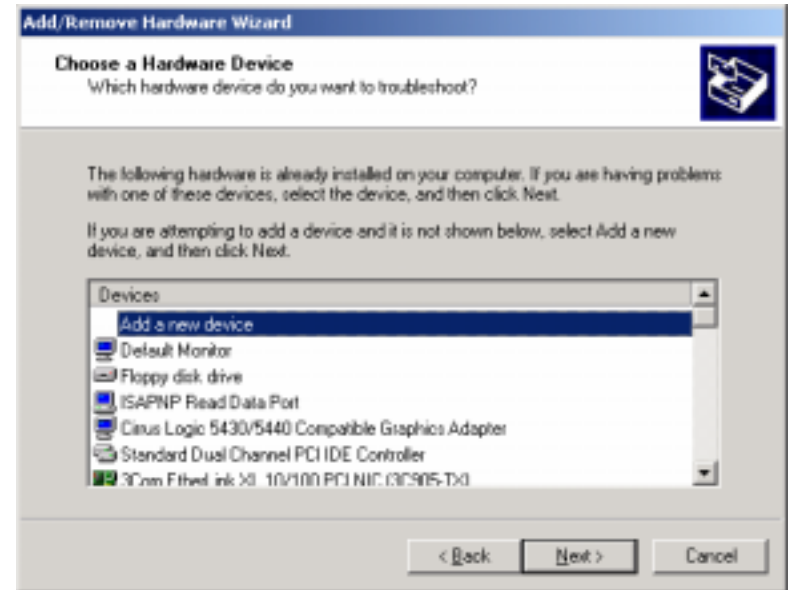

Click Add a new device.

Click Next.

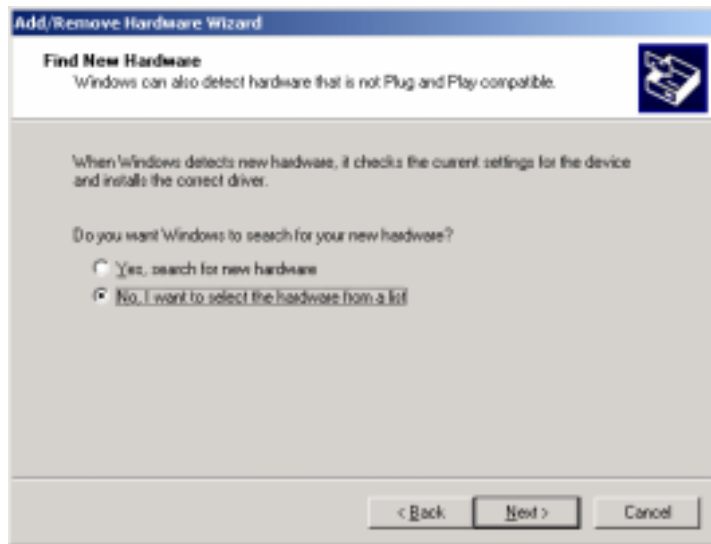

Click No, I want to select the hardware from a list.

Click Ports (COM & LPT).

Click Next.

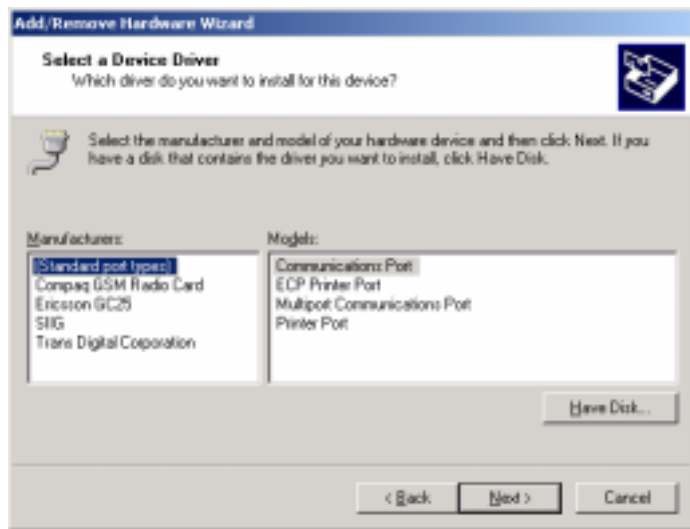

Select Standard port types and Communication Ports and Click Next. You will see the following screen, go ahead and Click OK.



The Resources area will allow you to set the IRQ and address of your new ports.

Click on the down arrow to the middle right of the screen after “Setting based on”:

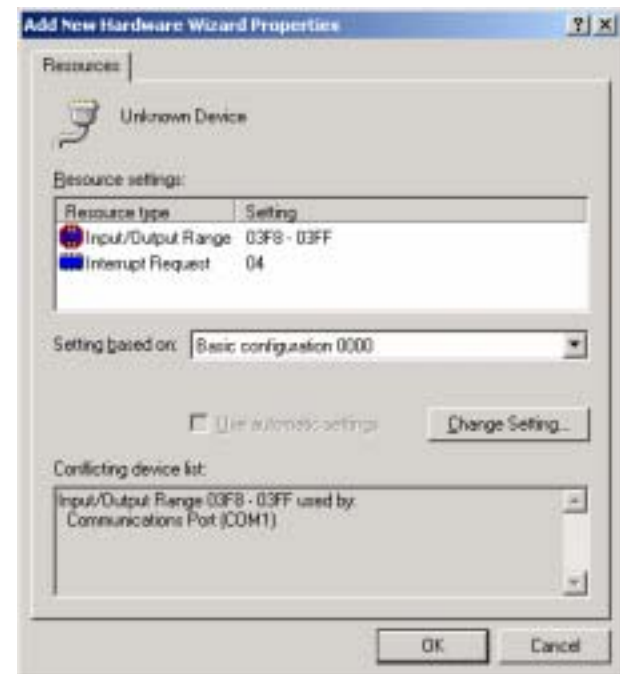

Click on the highest Basic configuration number in the list on the "Setting based on" category.

Double-click on the Input/Output Range to set the Address.

Double-click on the Interrupt Request to set the IRQ.

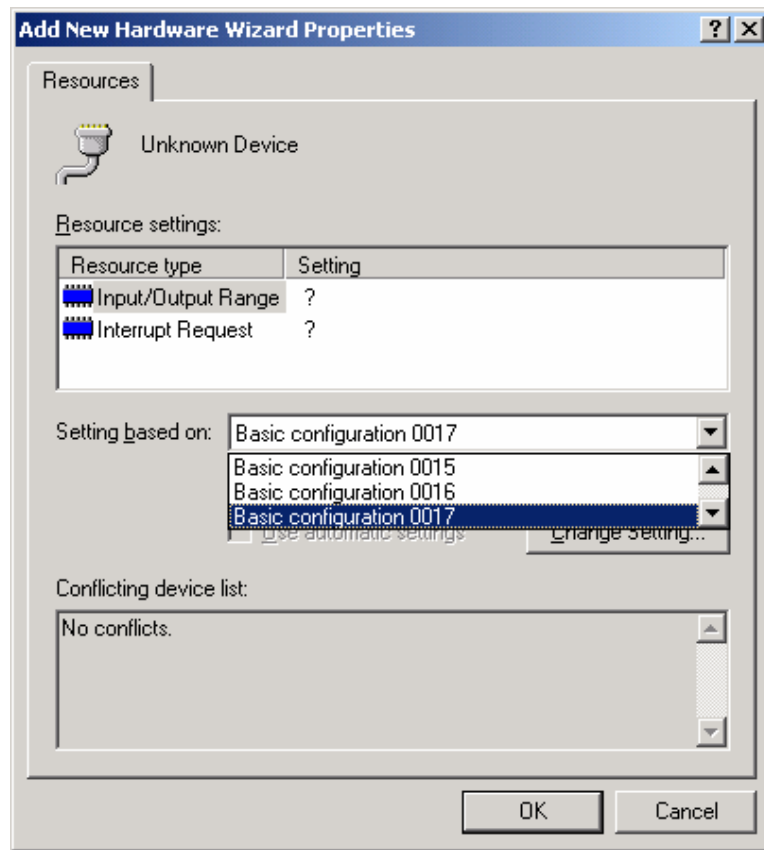

Select IRQ and Address that you want your port(s) configured at.

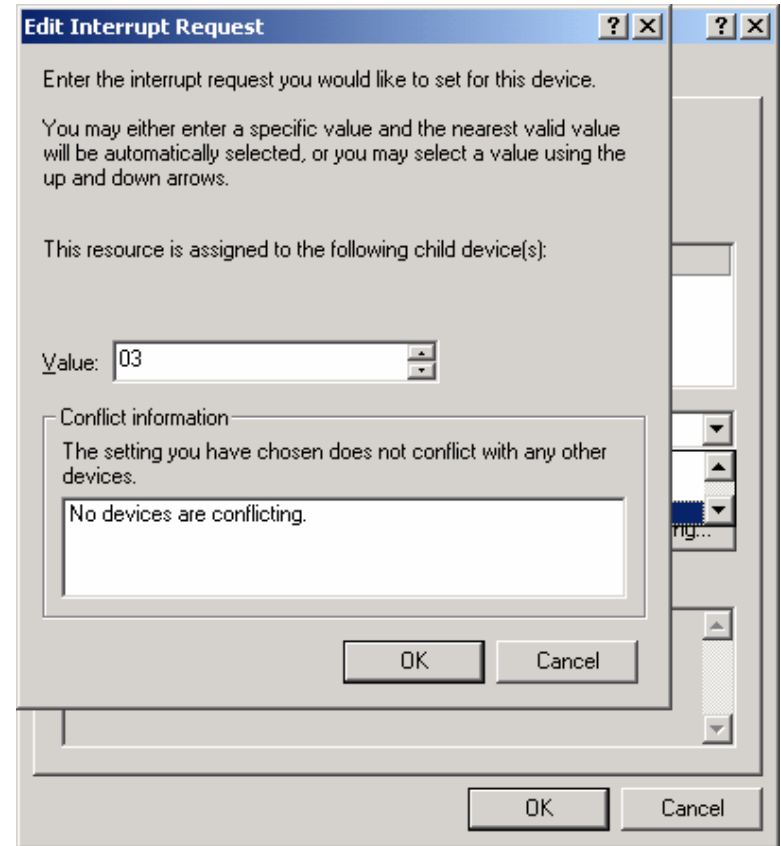

At this point you can shut down the system and physically install your B&B Electronics Serial Card into an available ISA slot. Double check to make sure the addresses and IRQ's on the Serial Card are set to the correct settings.

Chapter 4: Address and IRQ Setting

Address Switch Setup

A Windows PC has I/O port addresses and memory addresses. Some devices use both types of addresses. I/O port addresses have a 64K address space. Devices may decode all 16 address bits or only some of the lower bits. Traditionally, serial cards have only decoded 10 bits of the address bus. Recently this has begun to cause address conflicts with full 16 bit decoded devices, most notably between video cards and COM 4. B&B has solved these conflicts by decoding all 16 bits of the ISA address bus. Address settings in our ISA bus serial cards is set by DIP switches (selecting bits 11-4) or jumpers.

**CAUTION: Electrostatic Sensitive Device.
Use ESD precautions for safe handling.**

B&B Electronics 3PXCC cards are factory configured for COM1 IRQ4, and COM2 IRQ3 (2-port models). If you plan on installing the 3PXCC as standard COM1 and COM2, you may leave the address and IRQ set to the factory defaults.

The 3PXCC cards use a 7-position DIP switch to program the binary I/O address of each port on the card. Figure 1 is a drawing of the printed circuit board that shows the locations of the setup switches and jumpers on the 3PXCC cards.

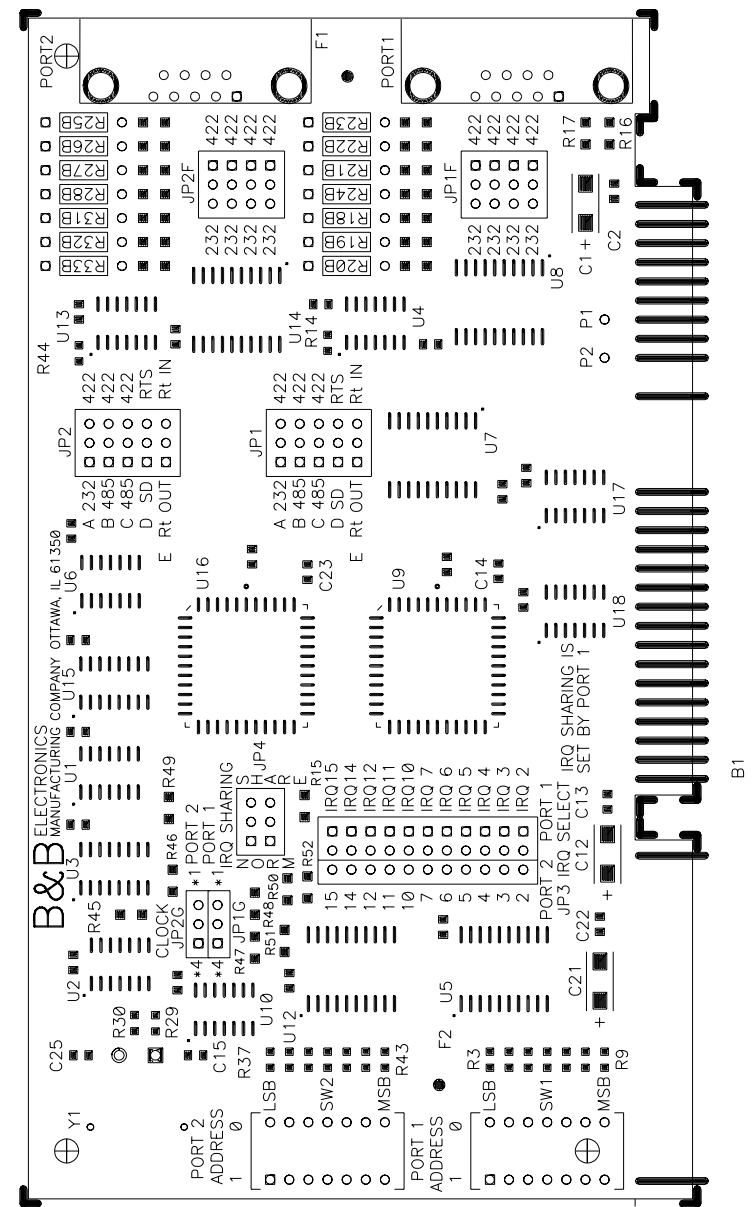

Figure 1. Silk Screen Plot of 3PXCC PCB

When setting the address (via the dipswitch) use the silkscreen on the printed circuit board. This silkscreen shows a “1” and a “0” to refer to the “on and “off” states that each switch is set to. Switch S1 configures port one (labeled J1) and, on two port cards, switch S2 configures port two (labeled J2). Least significant bit (LSB) and most significant bit (MSB) are labeled on the card. Table 1 shows the numerical weight and electrical connection of each switch position. Refer to Table 2 for COM port addresses. Table 3 shows frequently unused port addresses for applications when COM port addresses 1-4 are already used.

Table 1. Address Switches

Switch Position	7	6	5	4	3	2	1
Bus Connection	SA9	SA8	SA7	SA6	SA5	SA4	SA3
Decimal Weight	512	256	128	64	32	16	8
Hex Weight	200	100	80	40	20	10	8

To install the 3PXCC card as COM1, 2, 3, or 4, follow the switch settings shown in Table 2. To install at another address, follow the switch settings shown in Table 3.

Table 2. Standard Port Addresses

	Base Hex Address	Binary Equivalent	Switch Settings	
			MSB	LSB
			7654321	
COM1	3F8	1111111000	1111111	
COM2	2F8	1011111000	1011111	
COM3	3E8	1111101000	1111101	
COM4	2E8	1011101000	1011101	

Table 3. Frequently Unused Port Addresses

Base Hex Address	Binary Equivalent	Switch Settings		I/O Space Description
		MSB	LSB	
		7654321		
200	1000000000	1000000		game port
208	1000001000	1000001		game port
300	1100000000	1100000		prototype
308	1100001000	1100001		prototype
310	1100010000	1100010		prototype
318	1100011000	1100011		prototype
380	1110000000	1110000		SDLC
388	1110001000	1110001		SDLC
3A0	1110100000	1110100		bisync com
3A8	1110101000	1110101		bisync com

Interrupt Jumper Setup

The IRQ is a hardware Interrupt Request line in an ISA Bus expansion slot on a PC or AT compatible computer. The 8 bit PC ISA slot has 8 interrupts, the 16 bit slot has another 7 since one of the first 8 is used to link in the remaining 8. The IRQ is used by devices to request immediate service by the main microprocessor. When the IRQ line is set, the microprocessor stops whatever it's doing, saves status, checks which line was set, then jumps to code to handle the interrupt. The processor then clears the interrupt and returns to what it was doing before. IRQ lines are set by the internal timer, keyboard, hard drive controller, PCI, USB controller, sound card, serial ports, printer and more. The 3PXCC2 serial cards include special circuitry which allows one IRQ to be shared between the cards two ports even during simultaneous use. The software driver must support shared IRQs for this feature to work. Both Windows 9x and NT support shared IRQs. To configure both ports of the card to share one IRQ, set both jumpers of JP4 to the “Share” position. The Port 1 IRQ Select jumper should then be set to the desired IRQ. The Port 2 IRQ Select jumper is ignored when in shared mode.

The 3PXCC cards allow the use of interrupts (IRQ) 2, 3, 4, 5, 6, 7, 10, 11, 12, 14, and 15. Table 4 shows the standard serial port IRQ settings. NOTE: If two ports use the same IRQ setting, both ports cannot use the serial port at once. Only one port at a time may communicate.

Table 4. Standard IRQ Settings

COM1	IRQ4
COM2	IRQ3
COM3	IRQ4
COM4	IRQ3

Chapter 5: Communication Jumper Settings

This chapter will cover all of the jumper settings to set your B&B Serial Card for the proper communications that you desire.

**CAUTION: Electrostatic Sensitive Device.
Use ESD precautions for safe handling.**

RS-232 Mode

To configure a port for RS-232 mode, 5 jumpers must be checked. The following settings will configure Port 1 as RS-232.

1. JP1A - must be set in the "232" (left) position.
2. JP1F - all four jumpers must be set in the "232" (left) position.

Jumpers JP1B - JP1E have no meaning in RS-232 mode and may be in either position. Figure 2 shows the jumper configuration to set both ports for RS-232 mode.

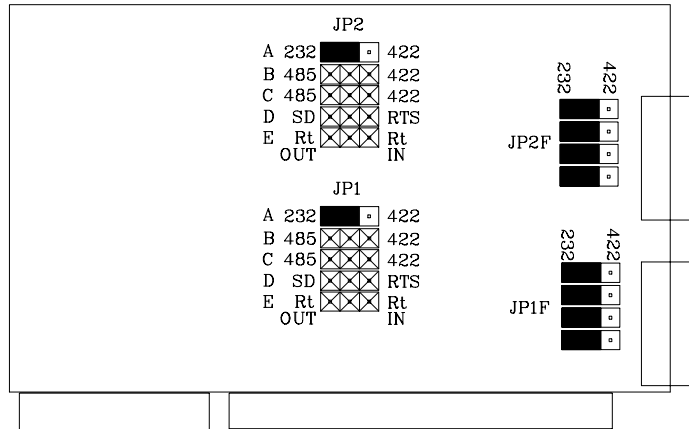

Figure 2. RS-232 Mode Jumper Settings

RS-422 Mode

To configure a port for RS-422 mode, 7 jumpers must be checked. The following settings configure Port 1 as RS-422.

1. JP1A, JP1B, JP1C - must be set in the "422" (right) position.
2. JP1F - all four jumpers must be in the "422" (right) position.

Figure 3 shows the jumper configuration to set both ports for RS-422 mode.

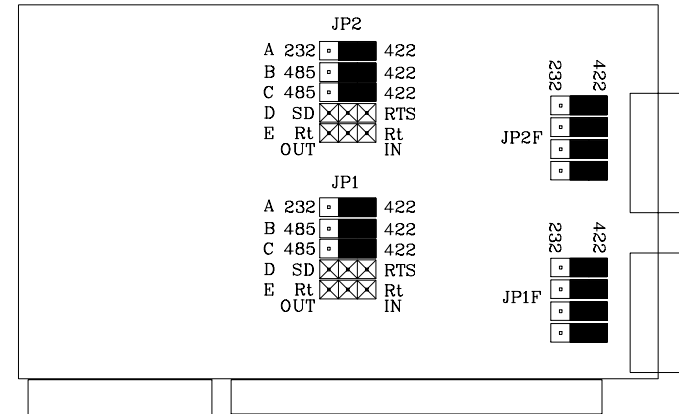

Figure 3. RS-422 Mode Jumper Settings

Note that the EIA RS-422 Specification labels data lines with an "A" and "B" designator. Some RS-422 equipment uses a "+" and "-" designator. In almost all cases, the "A" line is the equivalent of the "-" line and the "B" line is the equivalent of the "+" line. More information on RS-422 communications can be found in B&B Electronics' free RS-422/RS-485 Application Note.

RS-485 Mode

To configure a port for RS-485 mode, 9 jumpers must be checked. The following settings configure Port 1 as RS-485.

1. JP1A - must be set in the "422" (right) position.
2. JP1B, JP1C - must be set in the "485" (left) position.
3. JP1D, JP1E - set to match software and installation requirements.
4. JP1F - all four jumpers must be in the "422" (right) position.

Figure 4 shows the jumper settings for RS-485 mode.

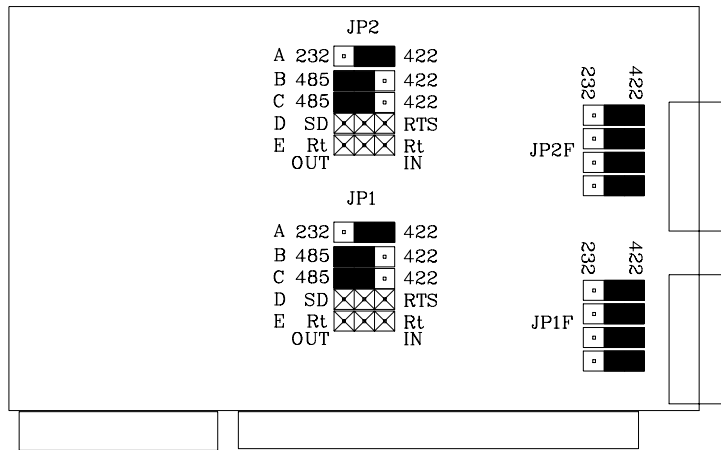

Figure 4. RS-485 Mode Jumper Settings

RS-485 Pinouts

The pinouts in RS-485 mode are the same as those listed in Table 7 for RS-422 mode.

RS-485 Operation

RS-485 mode requires that the driver be enabled and disabled as needed, allowing two or four-wire communications. To set up the 3PXCC1A Serial Card up for two wire mode you can simply jumper TD(A) to RD(A) (for your Data “-”) and TD(B) to RD(B) (for your Data “+”). Use the Signal Ground for your return path as the third wire in this configuration. For four wire mode, simply use all four data lines and signal ground for a return path.

The 3PXCC card provides two methods of enabling/disabling the driver: automatic send data (SD) control and request to send (RTS) control. With automatic SD control, the driver is enabled when data is transmitted. It remains enabled for the transmission time of one character after data transfer is complete. The SD circuit automatically adjusts its timing to the baud rate of the data. With RTS control, software must set the RTS bit to a logic 1 to enable the driver and logic 0 to disable the driver. To select SD control, place jumpers JP1D and JP2D in the SD position (left). Place these jumpers in the RTS position (right) for RTS control.

The receiver can also be enabled and disabled, a useful feature in two-wire communications to prevent the transmitted data from “echoing back” on its own receiver. Jumpers JP1C and JP2C control this feature for Port 1 and Port 2. If these jumpers are placed in the RS-485 position, the “echo” is turned off. This is achieved by disabling the receiver when the driver is enabled. Placing these jumpers in the RS-422 position will hold the receiver enabled at all times. More information on RS-485 communications can be found in B&B Electronics’ free RS-422/RS-485 Application Note.

RS-422 and RS-485 Termination

A 120Ω termination resistor has been provided for the RS-422/485 receivers. To enable the termination provided, place JP1E for Port 1 or JP2E for Port 2 in the Rt IN position (right). If you do not need to use termination, place the jumpers in the Rt OUT position (left). Termination should only be used when very long wiring runs are used with high baud rates. For example, with most cables which are 4000 feet or shorter and have baud rates at 19.2K baud or lower, termination is not required. Note that if the termination is enabled (IN), the biasing of the RS-485 network is altered and the value of the bias resistors will likely need to be changed somewhere on the network. More information on termination and biasing can be found in B&B Electronics’ free RS-422/RS-485 Application Note.

High Speed Mode

High data rates can be obtained with the 3PXCC cards by adjusting JP1G and JP2G. This multiplies the clock speed supplied to the UARTs by 4 times to 7.328MHz for ports 1 and 2 respectively, allowing data rates up to 460.8K baud in RS-422 and RS-485 modes. Note: RS-232 does not support these extended baud rates.

To use the higher clock rate, place the jumper for the appropriate port in the *4 (left) position. The jumpers are shipped from the factory in the standard clock (right) position.

Note that serial software is not aware of the change in oscillator frequency. For example, in the ×4 position, setting the baud rate to 57.6K baud in software will result in a actual baud rate of 230.4K baud. It is important to note that increasing the baud rate may not increase actual throughput. In heavy multitasking cases or with a slow computer, the computer’s inability to respond to interrupts quickly enough will cause large idle spaces between characters. Increasing the baud rate to this point will not increase actual throughput.

Chapter 6: Physical Hook-up and Troubleshooting

This chapter will cover 3PXCC pinout, communication cable data, and troubleshooting information.

Pinouts

RS-232 Pinouts

The 3PXCC Serial Cards are wired as DTE (Data Terminal Equipment) devices. The 3PXCC Serial Cards can be connected directly to DCE (Data Communication Equipment) devices with a straight through cable. If you need to connect two DTE devices, you will need a null modem cable or cross-over cable.

Table 5. RS-232 Pinout Description

Pin	Name	Description	Direction
1	DCD	Data Carrier Detect	input
2	RD	Receive Data	input
3	TD	Transmit Data	output
4	DTR	Data Terminal Ready	output
5	GND	Signal Ground	-----
6	DSR	Data Set Ready	input
7	RTS	Request to Send	output
8	CTS	Clear to Send	input
9	RI	Ring Indicator	input

RS-422 Pinouts

RS-422 mode supports transmit and receive data signals. The pinouts of the DB-9 connector are given in Table 6. Figure 5 shows how to connect a typical RS-422/RS-485 full duplex communication link.

Pin	Name	Description
1	RD(A)	Receive Data A
2	TD(B)	Transmit Data B
3	TD(A)	Transmit Data A
5	GND	Signal Ground
9	RD(B)	Receive Data B

Table 6. RS-422/RS-485 Pinout Description

RS-485 Pinouts

RS-485 mode supports both full and half duplex communications (transmit and receive data signals). The pinouts of the DB-9 connector are given in Table 6 (if full duplex communication is used). Figure 5 shows how to connect a typical RS-422/RS-485 full duplex communication link. Figure 6 shows how to connect a typical RS-485 half duplex communication link.

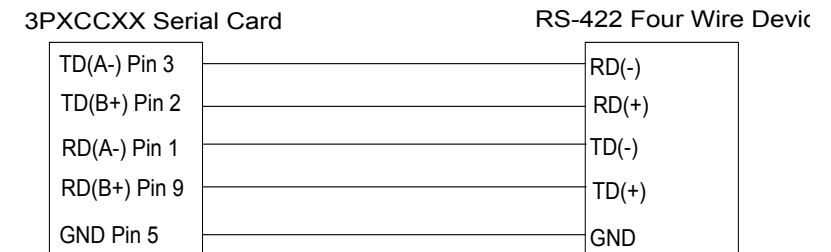

Figure 5. RS-422/RS-485 (Four Wire) Pinout Description

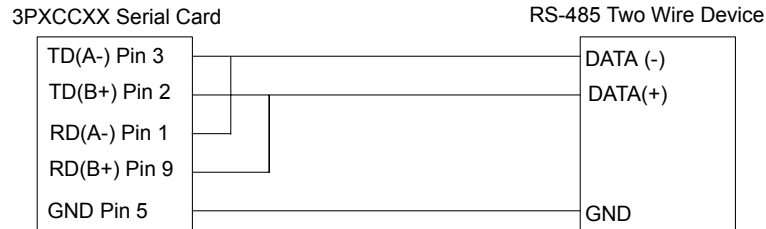

Figure 6. RS-485 (Two-Wire) Pinout Description

Communication Cable Data

The 3PXCC Serial Card communicates using RS-232, RS-422, and RS-485 communications. The communication cable specifications are 24AWG (wire gauge) and 30pF/ft. (capacitance rating). Twisted pairs are ideal for the RS-422/RS-485 Cable in order to suppress noise on the data line. B&B Electronics can provide this communication cable for RS-232 or RS-422/RS-485 Applications. The Model ETC8195 is a cable style that can be used for RS-232 Applications, and Model ETC8506 can be used for RS-422/RS-485 Applications.

Troubleshooting

If you are unable to communicate with the card from your software:

1. Consult your software manual to make sure it supports the address and interrupt that you have configured.
2. Double check that the address and interrupt are properly set.
3. Try another software package for troubleshooting. Download SimpTerm (DOS Terminal Emulator) or Comtest (Windows Terminal Emulator) from B&B Electronics' web site. SimpTerm and Comtest are shareware Simple Terminal Emulators that can be used to vary the setup of any serial card. Both can be downloaded from the following site location.

<http://www.bb-elec.com/support.asp>

4. Troubleshooting with a Loopback Test

Load Simpterm or Comtest on the test PC. When loading Simpterm you must set up the port address and IRQ you have set on the B&B Electronics serial card.

Jumper TD to RD on the DB9 male connector located on the serial card. You may have to make a "loopback connector" in order to do this. This is done by jumping pin 2 and pin 3 of a DB9 female connector and plugging it into the DB9 male port on the serial card.

To test the RS-232 handshake lines you can also jumper RTS to CTS and DTR to DSR. When you raise the RTS line you should see CTS also go high. When you raise the DTR line you should see DSR also go high.

Send data from the Serial Port (B&B Electronics serial card) and see if the data is echoed back to the port. When a character is typed on the keyboard you must see a duplicate character after the first character to verify that the same character was received. Perform this test on all ports of your serial card to verify the ports can (or cannot) transmit and receive data.

5. Call B&B Electronics' Technical Support at the number/s shown below:

International/USA Office:

(815) 433-5100, 8a.m. - 5:00 p.m. weekdays (Central USA Time).

European Office:

+353 91-792444, 8a.m. - 4:30 p.m. weekdays (UK).

Appendix A: Hardware I/O Map

I/O Map of XT Class Machines

Hex Address	Address Function in XT Class Machines
000-00F	DMA controller (8237A)
020-021	interrupt controller (8259A)
040-043	timer (8253)
060-063	PPI(8255A)
080-083	DMA page register (74LS612)
0A0-0AF	NMI - non maskable interrupt
200-20F	game port joystick controller
210-217	expansion unit
2E8-2EF	COM4 serial port
2F8-2FF	COM2 serial port
300-31F	prototype card
320-32F	hard disk
378-37F	parallel print
380-38F	SDLC
3B0-3BF	MDA - monochrome adapter and printer
3D0-3D7	CGA - color graphics adapter
3E8-3EF	COM3 serial port
3F0-3F7	floppy diskette controller
3F8-3FF	COM1 serial port

I/O Map of AT Class Machines

Hex Address	Address Function in AT Class Machines
000-01F	DMA controller #1 (8237A-5)
020-03F	interrupt controller #1 (8259A)
040-05F	timer (8254)
060-06F	keyboard (8042)
070-07F	NMI - non maskable interrupt & CMOS RAM
080-09F	DMA page register (74LS612)
0A0-0BF	interrupt controller #2 (8259A)
0C0-0DF	DMA controller #2 (8237A)
0F0-0FF	80287 math coprocessor
1F0-1F8	hard disk
200-20F	game port joystick controller
258-25F	Intel Above Board
278-27F	parallel printer port 2
2E8-2EF	COM4 serial port
2F8-2FF	COM2 serial port
300-31F	prototype card
378-37F	parallel printer 1
380-38F	SDLC or bisync com 2
3A0-3AF	bisync com 1
3B0-3BF	MDA - monochrome adapter
3BC-3BE	parallel printer on monochrome adapter
3C0-3CF	EGA - reserved
3D0-3D7	CGA - color graphics adapter
3E8-3EF	COM 3 serial port
3F0-3F7	floppy diskette controller
3F8-3FF	COM1 serial port

Any eight-byte space not used by one of the devices listed in the table and not used by any other equipment in your system may be used for the serial port.

Appendix B: Declaration of Conformity Statement

DECLARATION OF CONFORMITY	
Manufacturer's Name:	B&B Electronics Manufacturing Company
Manufacturer's Address:	P.O. Box 1040 707 Dayton Road Ottawa, IL 61350 USA
Model Numbers:	3PXCC1A, 3PXCC1B, 3PXCC2A, 3PXCC2B
Description:	RS-232 Serial Card
Type:	Light industrial ITE equipment
Application of Council Directive:	89/336/EEC
Standards:	EN 55022 EN 61000-6-1 EN 61000 (-4-2, -4-3, -4-4, -4-5, -4-6, -4-8, -4-11)
	
William H. Franklin III, Director of Engineering	
	